

G.L. PANKANIN, J. BERLIŃSKI, R. CHMIELEWSKI

Warsaw University of Technology
Institute of Electronic Systems
Poland, e-mail: g.pankanin@ise.pw.edu.pl

SIMULATION OF VORTEX STREET DEVELOPMENT USING MODEL WITH MODIFICATIONS

Two modifications of the analytical model of the vortex street development described in [1] have been proposed and simulated. The first one takes into consideration the movement of the stagnation region accordingly to vortex shedding. Introduction of a tapering duct sometimes used in practical designs instead of the duct of steady cross-section has been also considered. Simulations of both modified models enabled to formulate conclusions concerning the influence of the geometrical parameters on the vortices energy.

Keywords: numerical modeling, Karman vortex street, vortex meter

1. INTRODUCTION

The phenomenological model of the Karman vortex street has been proposed in [1]. Results of the simulation with application of the model have been presented in [2]. Obviously, the model has been constructed with some simplifying assumptions. In the current article, two new elements are introduced to the model. The first one concerns making the stagnation region movable accordingly to Birkhoff's model [3]. The second modification is related to the idea of introduction of a tapered duct instead of its fixed cross-section.

The presented simulations of the phenomena using a model with modifications were carried out for a circular cylinder as the bluff body located in the duct perpendicularly to the flow direction. It was assumed that the vortex radius increases linearly versus its current position. Vortex development in each zone has been split into 10 steps. One layer has been added to the vortex in each step. The assumed flow velocity was equal to 1m/s.

2. SHORT DESCRIPTION OF THE MODEL

The worked-out model described in [1] is based on a simple configuration where the circular cylinder is placed in the duct (Fig. 1). Eddies originated on the bluff body surface enlarge rolling downstream on the surface of the stagnation region. Succeeding layers are added to the vortex causing an increase of its diameter and energy.

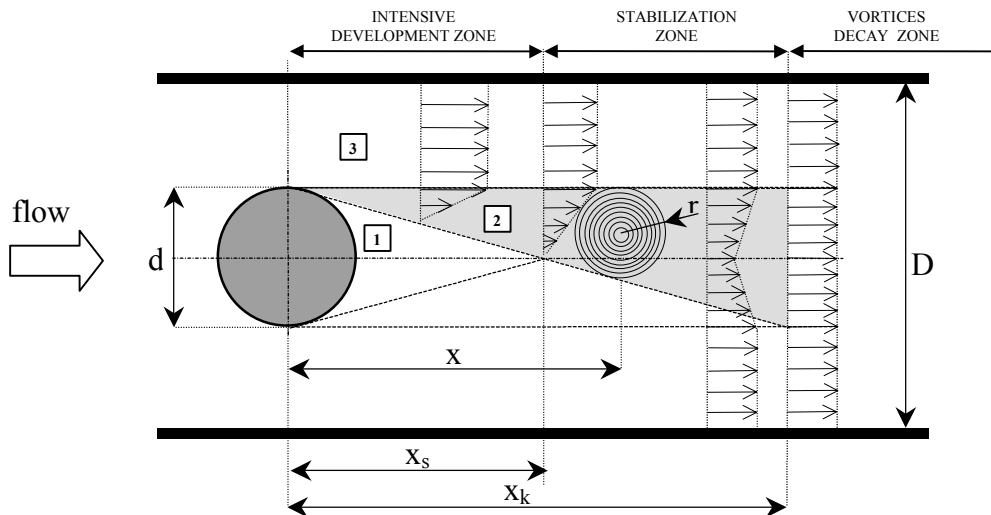

Fig.1. Development of consecutive vortices downstream bluff body (1 - stagnation region, 2 - region of vortices development, 3 - region of steady velocity profile).

As can be seen in Fig. 1, the vortex development may be considered in three zones: intensive development zone, stabilization zone and decay zone. The conditions of vortex development are different in the three zones. A detailed mathematical description of the model has been presented in [1].

3. MODEL WITH MOVING STAGNATION REGION

3.1. Model description

In the model proposed in [1] it was assumed that the stagnation region is unmovable. It should be noticed, however, that the region appears as an information canal on generated vortices. This information must be transferred to the other side of the bluff body in the course of initialization of further vortex generation. Birkhoff [3] suggested in his model that oscillatory movement of the stagnation region in form of oscillations ensures such transfer. Let us assume that the vortices flowing off the bluff body enlarge rolling on the stagnation region boarder and simultaneously they press this region (like a rigid body) causing a pendulous motion with the axis of rotation located in the center of the bluff body. After reaching the end of the stagnation region, the return movement is initiated with consecutive vortex development on the reverse side of the bluff body (Fig. 2).

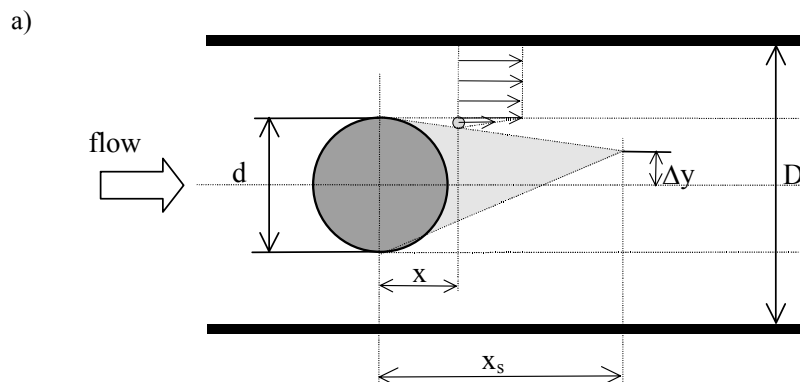

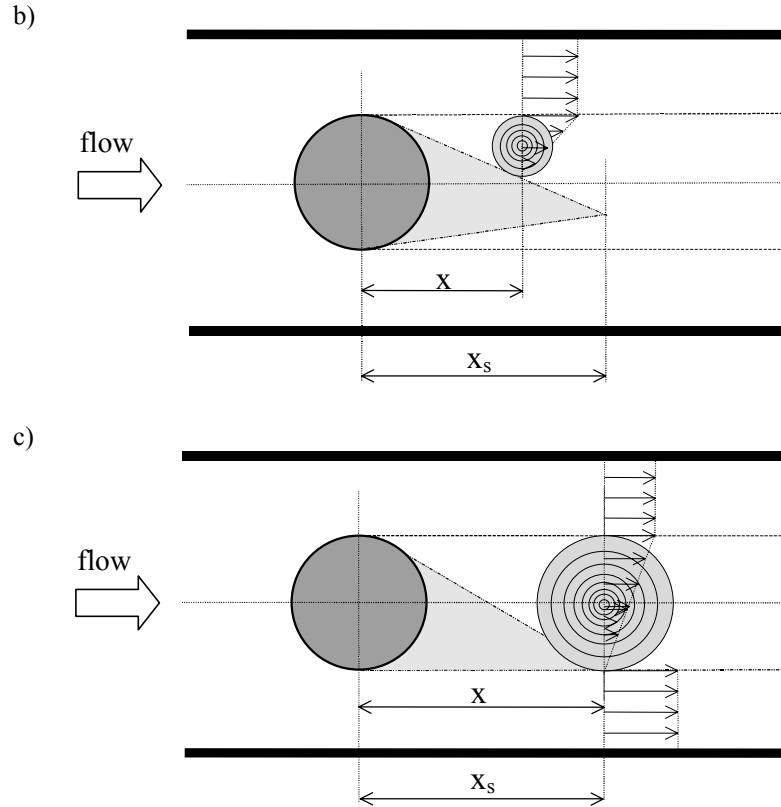

Fig.2. Vortex development in the model with moving stagnation region (a: $x/x_s = 0.33$, b: $x/x_s = 0.66$, c: $x/x_s = 1$).

Introduction of the pendulous movement of the stagnation region causes considerable changes in modeled vortex development. The vortex is growing more intensively and yields more energy than in the case of a stable stagnation region.

Let us assume that the tip of the stagnation region makes harmonic movements with a relative amplitude defined as follows:

$$a = \frac{2\Delta y}{d}. \quad (1)$$

The maximal value of the relative amplitude is obtained for $a = 1$, while $a = 0$ means the still stagnation region. Analyzing the velocity distribution in the pipe, the velocity "forcing" the vortices can be calculated as follows:

$$v_{pc} = v \frac{D}{D - d + \frac{1}{2} \frac{x}{x_s} dA}, \quad (2)$$

where:

$$A = 1 - a \cos\left(\frac{x}{x_s} \pi\right). \quad (3)$$

The vortex radius is a function of the distance from the separation point and depends on the current location of the stagnation region:

$$r = \frac{x}{x_s} \frac{d}{4} A. \quad (4)$$

The rotation of the currently generated vortex layer is described by the equation:

$$\omega = v \frac{Dx_s}{\pi x d A (D - d + \frac{1}{2} \frac{x}{x_s} d A)}. \quad (5)$$

The other equations describing the model (especially concerning the vortex energy calculation) were presented in [1] and will not be repeated here.

It results from the above formulas that in the case of a moving stagnation region the vortex development process proceeds more violently. This intensity depends on the amplitude of oscillations of the stagnation region.

In the case when the amplitude a is almost 1, the stabilization zone practically does not exist. The vortex diameter is sufficiently great and after leaving of intensive development zone, consecutively joined layers are not forced by the stream.

3.2. Results of simulation

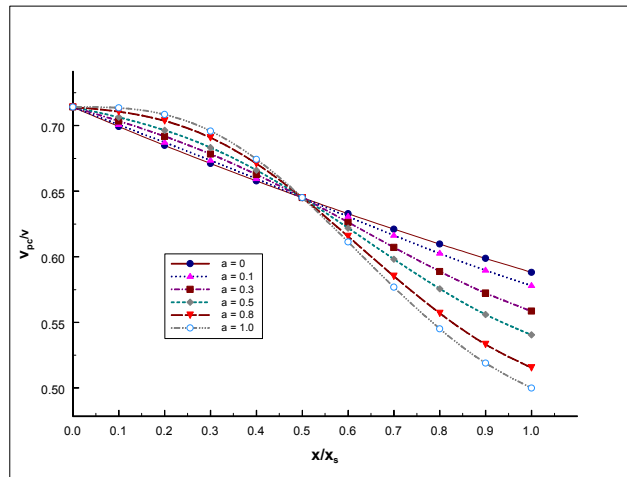

Fig.3. Relative velocity forcing the vortex as a function of distance from the bluff body axis for various amplitudes of stagnation region movement.

For the model with movable stagnation region, a considerable increase of the velocity forcing initially joined layers and a decrease for further ones is observed (Fig. 3). This effect is amplified with the increase of oscillation amplitude. Stronger rotation of the layer, however, does not mean a higher rotation energy. As seen in Fig. 4, the mass of the joined layers is decisive and the highest rotation energy is carried by the layers generated closer to the stagnation region end.

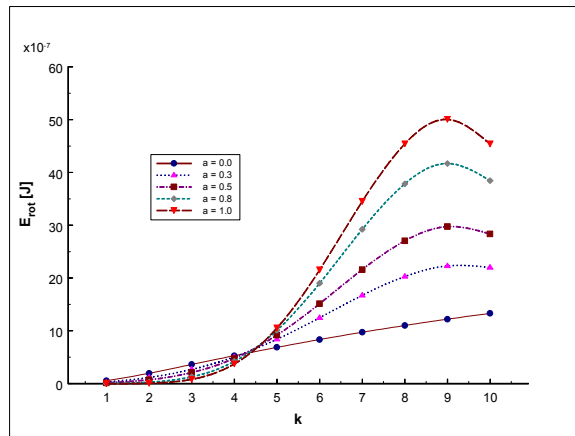
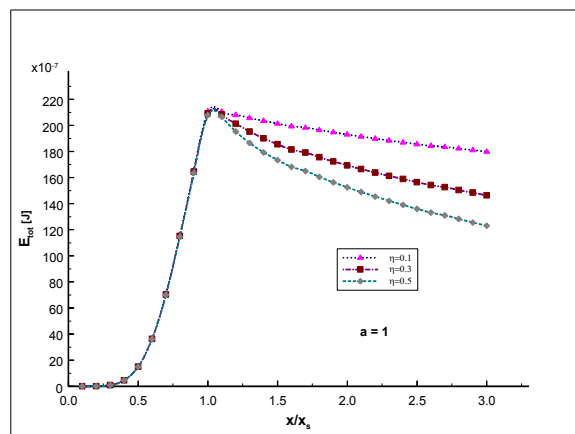

Fig.4. Rotation energy distribution in the vortex for various amplitudes of the stagnation region movement.

Total rotation energy of the vortex vs. its location (distance from the separation point) for various fluid viscosities is shown in Fig. 5. The curves are very similar to the ones obtained for the model with a stable stagnation region presented in [2]. Also in this case there appears a violent vortex energy increase and - after reaching a maximum - the vortex is gradually fading.



Rys.5. Total rotation energy of the vortex vs. current location, for various fluid viscosities.

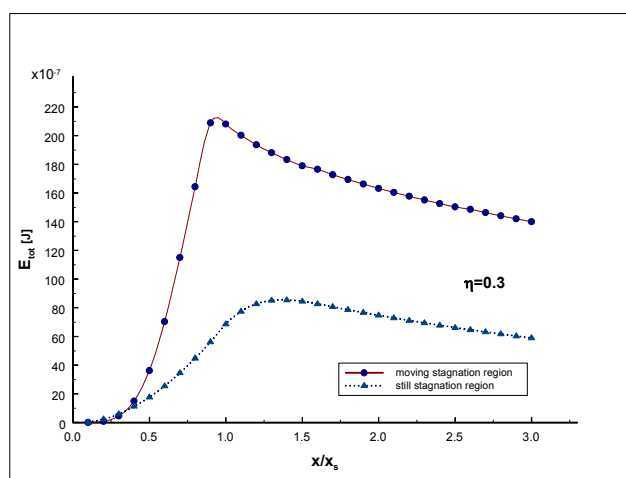

Fig. 6. Influence of stagnation region movement on vortex total rotation energy.

The comparison of simulation results gained for both cases, with still and moving stagnation region, is shown in Fig. 6. It is easy to notice that the curve obtained for the moving stagnation region reaches the maximum earlier (at a smaller distance from the separation point). But – first of all – the maximal total rotation energy is more than 2 times higher than in the case of a still stagnation region.

4. MODEL WITH TAPERING DUCT

4.1. Description of the model

In various types of flowmeters a local decrease of pipe diameter is applied, resulting in an increase of flow velocity. It is caused by the low flow rate limitation resulting from non-appearance of applied phenomena or from their increased irregularity. Hence the idea arose of making contraction of a jet in the area of generation and development of Karman vortices. The configuration of a tapering duct with the bluff body placed inside is as shown in Fig. 7.

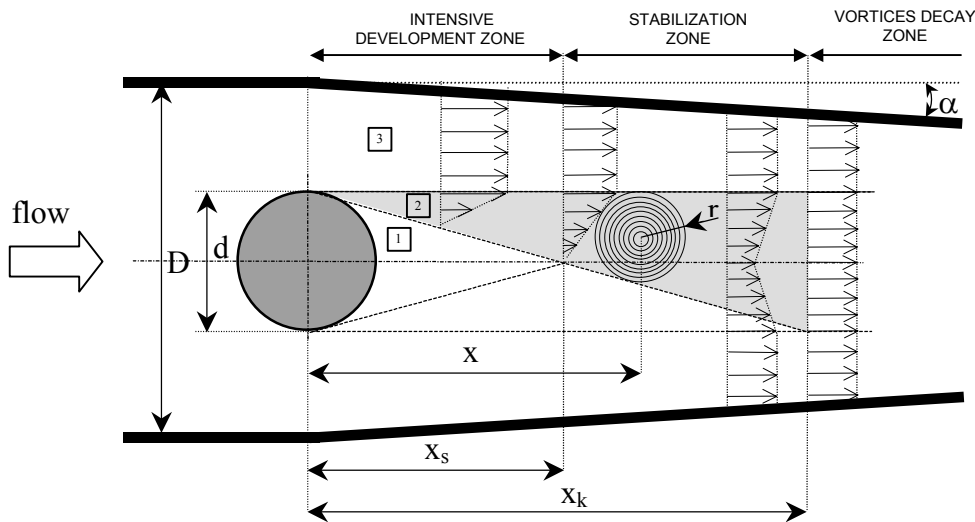

Fig.7. Vortex development in tapering duct (1 - stagnation region, 2 - region of steady velocity profile, 3 - region of vortices development).

Likewise as in the originally proposed model, three zones of vortex development have been distinguished:

- intensive development zone,
- stabilization zone,
- vortices decay zone.

In the intensive development zone the velocity „forcing” the joining vortex layer depends on the angle α and is higher than in the case of a stable width duct:

$$v_{pc} = \frac{v}{2} \frac{D}{D - d + x \left(\frac{d}{2x_s} - 2tg\alpha \right)}. \quad (6)$$

The rotation of the generated layer is expressed as follows:

$$\omega = \frac{vx_s}{\pi dx} \frac{D}{D-d+x\left(\frac{d}{2x_s}-2tg\alpha\right)}. \quad (7)$$

In the stabilization zone the „forcing” of one by one joined layers becomes significantly weaker than in the intensive development zone. Due to application of duct contraction, however, an increase of the forcing velocity v_{pc} in relation to the duct of stable width has been attained:

$$v_{pc} = v\left(1 - \frac{x}{2x_s}\right) \frac{2D(x_k - x) + 4x(x - x_s)tg\alpha}{(x_k - x_s)(2D - d - 4xtg\alpha)}. \quad (8)$$

Rotation of the generated layer is expressed by the equation:

$$\omega = \frac{2vx_s}{\pi dx} \left(1 - \frac{x}{2x_s}\right) \frac{2D(x_k - x) + 4x(x - x_s)tg\alpha}{(x_k - x_s)(2D - d - 4xtg\alpha)}. \quad (9)$$

In the vortex decay zone, similarly like in the model with stable duct width, new layers are joined but they are not forced by the stream.

Also in the case of this modification the reader is referred to article [1] where other equations describing the model are shown.

4.2. Results of simulation

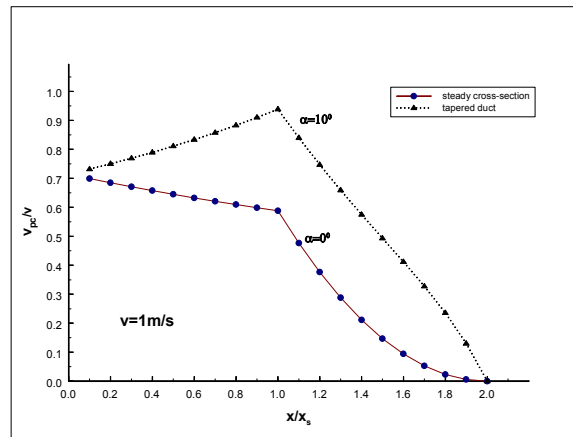

Fig.8. Relative velocity forcing the added vortex layers vs. distance from the bluff body axis.

Velocity forcing the currently added layers as a function of the distance from the separation point for the tapered duct ($\alpha = 10^\circ$) and for the duct with stable width are shown in Fig. 8. Particularly significant differences appear in the intensive development zone. In the case of a stable duct width the velocity gradually decreases, whereas the contraction (for $\alpha > 4.5^\circ$) causes its increase. In the stabilization zone the velocity v_{pc} is considerably higher for the model with the pipe contraction. An increase of the velocity forcing the layers must result in a significant increase of rotation energy.

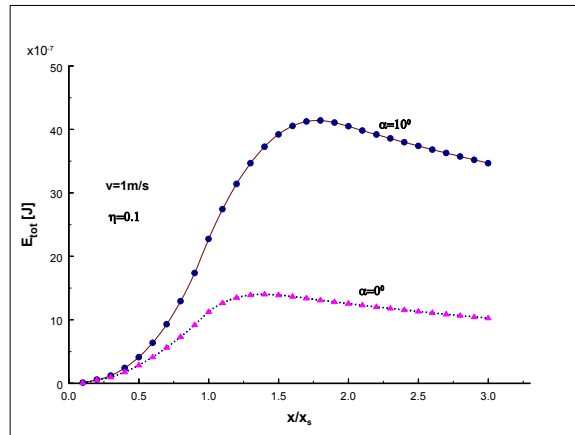

Fig.9. Total rotation energy of the vortex vs. distance from the bluff body axis.

On the basis of the graphs presented in Fig. 9 it can be remarked that due to pipe contraction, a considerable increase of rotation energy (approx. 3-times when $\alpha = 10^\circ$) can be gained. It is also worth to notice that maximum vortex energy for the model with tapering duct appears at a greater distance from the separation point. It means that the process of vortex development lasts longer and the vortices can be easier detected.

5. CONCLUSIONS

Two modifications of the analytical model of the Karman vortex development have been presented in this paper. It should be underlined, however, that these modifications did not change the overall conclusions which concerned the original model described in [1].

The first modification was originated on the old hypothesis formulated by Birkhoff in [3] concerning the oscillation movement of the stagnation region just downstream the bluff body. Introduction of the moving stagnation region into the model causes quantitative changes in the development of vortices. Due to the region movement, the velocity forced the vortex as well as its growth became more vigorous. Due to very fast vortex development, an essential increase of rotation energy is visible. It results from significantly quicker vortex enlargement, especially at the very back of the vortex development region. In close vicinity of the bluff body, however, in spite of the relatively high velocity which forced the vortex, its energy is rather negligible. It is caused by very small vortex mass in this area. From the point of view of vortex energy preservation, it is very significant that most of the energy is concentrated in very few layers. Hence, the energy losses (caused by viscosity friction) are less noticeable than in the case of the model with a still stagnation region.

Simulation of the model with modified configuration has been also presented in the paper. It can be found as an example of application of the model for the solution of real design problems. Due to duct contraction, a considerable improvement of the quality of the measuring signal is expected. On the basis of numerical simulation it may be concluded that the duct contraction causes an essential increase of the velocity “driving” the vortex. It results in an increase of the vortex rotation energy as well. Very interesting is also the fact that due to duct contraction, a vortex life-time increase has been attained. It was clearly confirmed by the laboratory tests carried out in a hot-wire anemometer system [4]. It is necessary to underline, however, that the possibility of an extension of the duct contraction is limited. Too great contraction may cause deterioration of vortex quality as well as an increase of pressure losses.

NOTATION

- d - bluff body diameter
- v_{pc} - flow velocity 'driving' the vortex
- v_{px} - current flow velocity at the distance x from the pipe axis
- ω - vortex angular velocity
- x - current vortex displacement from the bluff body axis
- x_k - length of intensive development and stabilization zones
- D - width of the pipe
- r - radius of the vortex
- η - dynamic viscosity
- E_{rot} - rotation energy of the layer
- E_{tot} - total rotation energy
- k - number of layer
- a - relative amplitude of stagnation region movement
- Δy - current displacement of the stagnation region end

REFERENCES

1. Pankanin G.L., Berliński J., Chmielewski R.: *Analytical modeling of Karman vortex street*, Metrology and Measurement Systems, Metrology and Measurement Systems, vol. XII, no. 4(2005), pp. 413-425.
2. Pankanin G.L., Berliński J., Chmielewski R.: *Simulation of Karman Vortex Street Development Using a New Model*, Metrology and Measurement Systems, Metrology and Measurement Systems, vol. XIII, no. 1(2006), pp. 35-47.
3. Birkhoff G.: *Formation Vortex Street*, Journal of Applied Physics vol.24 no. 1(1953), pp. 98-103.
4. Pankanin G.L., Berliński J., Chmielewski R.: *Numerical Modelling of Vortices Development in Tapered Duct*, Proc. of the International Symposium on Flow Measurement FLOMEKO XI, Groningen, The Netherlands, May 12-14, 2003, CD-ROM proceedings.